

Design of CMOS Power Amplifier with Resistive Feedback and Notch Filter for UWB Systems

D.S.A.A. Yusuf, R. Sapawi, S.M.W. Masra, S.K. Sahari, M. Sawawi, D.A.A. Mat, A.S.W Marzuki, N. Zamhari
Department of Electrical and Electronic Engineering,
Faculty of Engineering, Universiti Malaysia Sarawak, 94300, Kota Samarahan, Sarawak, Malaysia.
srohana@unimas.my

Abstract—A CMOS power amplifier (PA) with the implementation of the notch filter designed for ultra-wideband (UWB) systems is presented in this paper. The design is consisted of two stages of amplifier involving source follower and common source topologies with a notch filter and an output matching network. Such design is meant for full band UWB applications that utilize the frequency range within 3.1 GHz to 10.6 GHz with the elimination at 5-6 GHz using 0.18 μm CMOS process. The simulation shows that the proposed PA design achieved 19.25 dB maximum gain with 1.8 V power supply. In this work, the achieved input and output return loss ranging from -8.13 dB to -19.19 dB, and -1.68 dB to -16.03 dB, respectively, through full band frequency.

Index Terms—Notch Filter; Power Amplifier (PA); Radio Frequency (RF); Ultra-wideband (UWB)

I. INTRODUCTION

Ultra-wideband (UWB) is commonly used in wireless communications, with most of its applications are utilized in advanced radar and imaging systems. As stated by the Federal Communication Commission (FCC), the UWB is defined as a signal within 3.1 GHz to 10.6 GHz with a bandwidth of more than 500 MHz or a fractional bandwidth that is larger than 20% of the operating bandwidth. In UWB transmissions, there are two technologies that have been introduced, which are direct-sequence ultra-wideband (DS-UWB) and multi-band orthogonal frequency division multiplexing (MB-OFDM), as shown in Figure 1. For DS-UWB, the signal travels in a series of impulses that will cause the spectrum to be in very wide bandwidth. On the other hand, the MB-OFDM uses a wideband or multiband signal operating at 500 MHz bandwidth. The signal then bounces in frequency to achieve high bandwidth. The DS-UWB is usually used in high data rate transmissions such as for short-range transmission while MB-OFDM is used in wireless communications.

Even though the UWB frequency range lies within 3.1 to 10.6 GHz, there are other bands at frequency of 5 GHz to 6 GHz, reserved for HiperLAN and UNII communication systems. The existence of these networks might cause interference to UWB signals. To overcome this problem, the amplifier used in UWB application must be equipped with a filter to eliminate these frequencies.

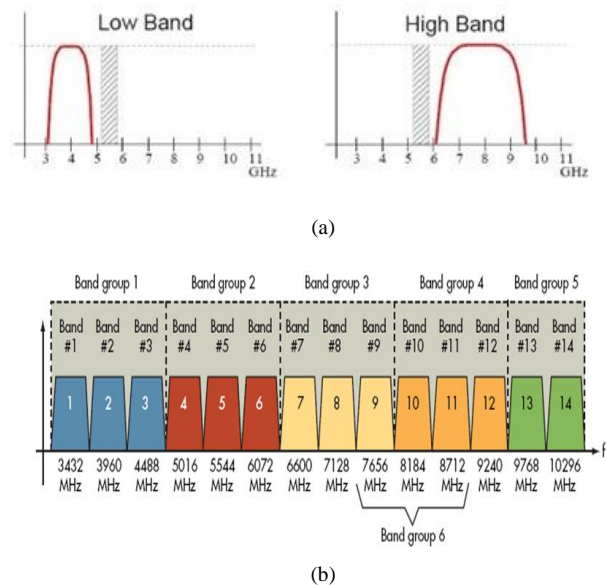

Figure 1: Spectrum allocated for UWB communication; (a) DS-UWB, (b) MB-OFDM.

There are various researches have been done in power amplifier designed for UWB applications available in the literature. Different topologies were used according to UWB applications which depends on the operating frequency. Each topology will produce different result of PA's parameters. In [1], all designs for UWB PA have been reviewed. The most popular topology for PA UWB is current reuse topology [2]-[6], because of its ability to improve gain flatness and achieve low power. However, none of the design is able to perform in a full band UWB operation. For full band applications, the commonly used topologies are distributed amplifier, resistive shunt feedback and stagger tuning. Distributed amplifier [7]-[8] and stagger tuning [9]-[10] topologies achieve a good gain and wideband matching but have a major drawback in which they consume high power. In UWB systems, it is very important for power amplifier to operate at a very low voltage and consume low power because to achieve an energy-efficient communication.

Up to date, there is no existing power amplifier design that includes a filter to eliminate a certain range of frequency. Therefore, this paper focuses on designing a power amplifier with high gain, better stability and low voltage with the implementation of the notch filter to eliminate 5-6 GHz.

II. CIRCUIT DESIGN

The proposed PA design can be divided into three stages of task. The first stage involves resistive feedback to get a good impedance matching network and a cascaded source follower technique for achieving better stability. Next stage is the inter-stage of design in which the notch filter is designed using LC configuration. Finally, the last stage involves a cascaded common source configuration to boost the power gain of amplifier and output matching network. The complete design is shown in Figure 2.

In such figure, capacitors C_1 and C_5 act as DC blocking capacitors to evade the DC signal from flowing into the circuit. Cascade amplifiers with resistive feedback are implemented during the first stage of design because of its ability to give a high-frequency response and better reverse isolation. Current from resistor R_2 will flow back into the input for good input matching thus achieving the best broadband gain. The value of R_2 also will affect the stability of the amplifier. Reduction of resistor's value will lead to better stability but can reduce the gain. Moreover, the use of feedback resistors will large value may decrease the effect of feedback design. Therefore, the value of R_2 must be selected carefully to produce good stability and to maintain an appropriate gain for the PAs.

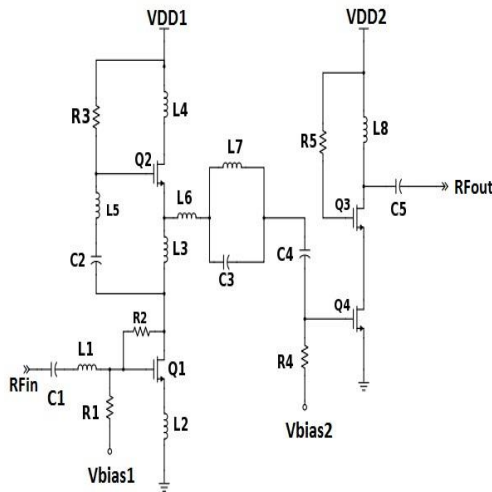

Figure 2: Proposed UWB PA with notch filter

Inductor L_1 and capacitor C_1 are used to produce a series resonance to achieve a complete input matching network. Inductor L_3 provides a high impedance path for signal blocking at a certain bandwidth. Thus, it is set to a large value. In this design, the selected value of the L_3 is 1.24nH.

Inductor L_5 and capacitor C_2 form a narrow band characteristic [11] to achieve lower impedance path. To produce the inductive peaking effect, inductors L_4 and L_8 are applied to the source of transistors Q_2 and Q_3 respectively to expand the frequency range and to improve gain flatness for the overall power amplifier performance. R_3 acts as a biasing circuit to allow Q_2 to be in the ON state. The same condition is applied to Q_3 , with R_5 is used as a biasing resistor. R_1 and a power supply with 0.8V work together as a biasing circuit to turn on transistor Q_1 . On the other hand, R_4 and another power supply are used to enable transistor Q_4 .

During the inter-stage development of the power amplifier, a notch filter built from LC tank is designed to eliminate the unwanted frequencies. The details on such notch filter design

will be discussed in another section in this paper. Table 1 shows the summary of all components used in the proposed UWB power amplifier with a notch filter.

A. Gain Analysis

The proposed PA design embraces a two-stage cascade configuration to obtain sufficient power and wide bandwidth. The first stage is used to oscillate lower band while the other stage is used for higher band oscillation. To obtain a broadband gain and good matching network, a resistive feedback is used. Resonance circuit designed in both first and second stages are then applied to sustain the high gain until the end of the desired frequency. In this design, a resonance circuit is used to control the flatness of the gain and the length of bandwidth. The difference value of the resonance elements affects the gain wide, and both starting and end points of the bandwidth. Figure 3 shows the effect of variation values in L_8 as one of the resonance element.

Table 1
Device dimension

Parameter	Device dimension Devices Size
Q_1	0.18 x 6 (μm)
Q_2	0.18 x 5 (μm)
Q_3	0.18 x 9 (μm)
Q_4	0.18 x 6 (μm)
L_1	1.29 (nH)
L_2	178.25 (pH)
L_3	1.24 (nH)
L_4	1.27 (nH)
L_5	577.65 (pH)
L_6	680.50 (pH)
L_7	891.92 (pH)
L_8	2.95 (nH)
C_1	2.8 (pF)
C_2	80 (fF)
C_3	800 (fF)
C_4	1.5 (pF)
C_5	1.5 (pF)
R_1	10K Ω
R_2	3K Ω
R_3	5K Ω
R_4	4K Ω

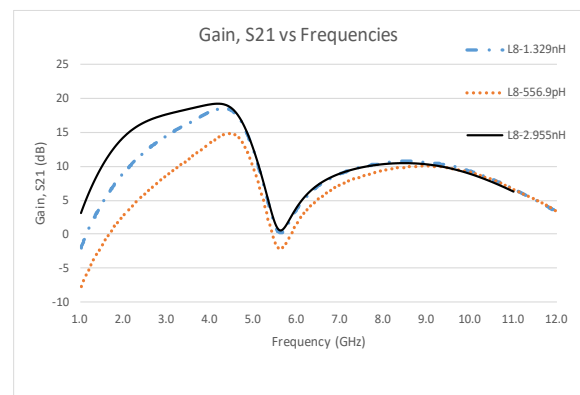

Figure 3: Effect of L_8 towards Gain

B. Notch Filter Design

There are some other signals located in the spectrum of UWB frequencies such as signals used for wireless LAN IEEE 802.11a applications (i.e., at 5-6 GHz). The interference caused by such signals might affect the operation of UWB systems. The best way to overcome this problem is by eliminating such unwanted signal by using a filter. There are a few types of filters that can be used to discard reserved

frequency in order to minimize the interference's effect. The best filter is notch filter/bandstop filter because of its ability to filter out the particular range of frequency while not interrupting the operation of the amplifier. The notch filter has a very narrow and deep rejection around its centre frequency. This filter takes a Q-factor value importantly because it will influence the cut-off slopes of the filter. The higher value of Q will produce the sharper cut-off slopes.

Therefore, the notch filter is proposed for the inter-stage development of the power amplifier in this design. The notch filter configuration as shown in Figure 4 involves a series LC-tank in RF signal path. The impedance of the notch filter is given by the equation (1) and then is simplified as provided in equation (2). Rejection frequency for notch filter can be derived by using equation (3). Figure 5 shows the effect of notch filter towards the power gain of UWB power amplifier. At 5 GHz, the gain decreased below 10 dB, indicating that the amplifier is not working at this frequency but then bounce back higher than 10 dB in the upper band of frequency.

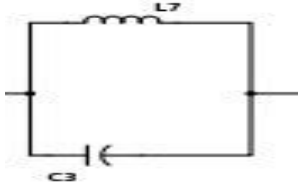

Figure 4: Design of Notch Filter

$$Z = \frac{Z_{L7} Z_{C3}}{Z_{L7} + Z_{C3}} \quad (1)$$

$$Z = \frac{sL_7}{s^2 L_7 C_3 + 1} \quad (2)$$

$$f_{notch} = \frac{1}{2\pi\sqrt{L_7 C_3}} \quad (3)$$

In the notch filter design, the values of inductors and capacitors contribute to the performance of the filter itself. A variation of inductor values with the same centre frequency (5GHz) affects the deep of rejection band and the point of where the rejection took place. Meanwhile, the value of capacitor is used to determine the frequency of rejection. Therefore, the values of both components need to be chosen carefully to achieve an optimum filter effect at the desired frequency and an excellent performance of notch filter. Figures 6 and Figure 7 illustrate the effect of different values in L and C towards the gain of UWB PA performances.

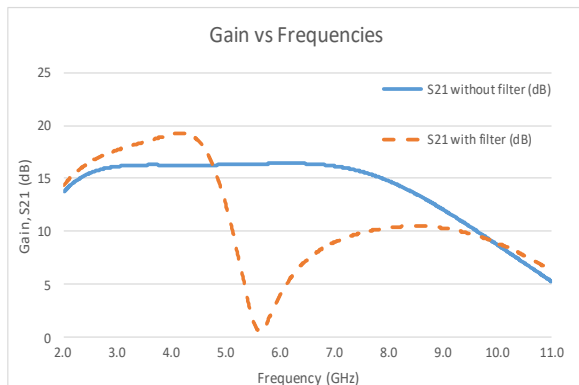

Figure 5: Effect of Notch Filter towards gain, S_{21} .

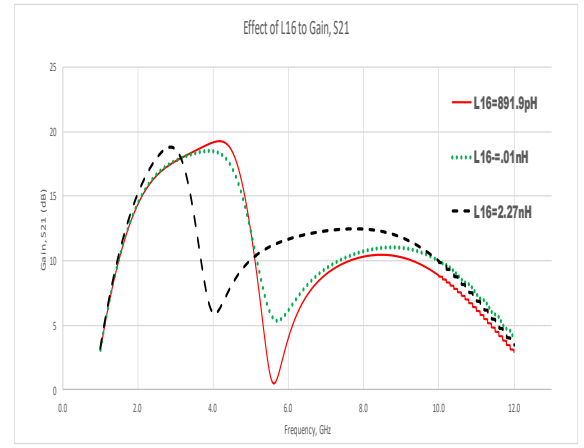

Figure 6: Effect of value L_{16} towards the rejection of gain.

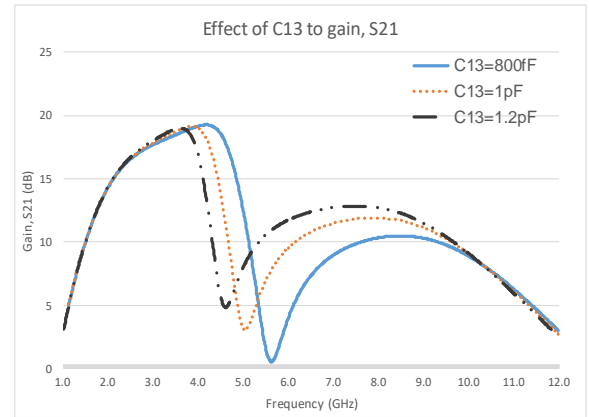
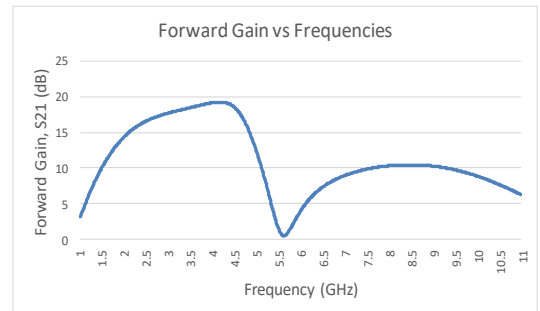

Figure 7: Effect of C_{13} towards the frequency of rejection band.

III. SIMULATION RESULT

The simulation results of the proposed UWB PA using a $0.18 \mu\text{m}$ technology is shown in Figure 8. At the operating frequency of 3.1-4.9 GHz, the maximum power gain of 19.25 dB is achieved at 4.16 GHz. At 5 GHz, the forward gain dropped to below 10 dB, indicating that the power amplifier is disabled due to the notch filter operation. The input and output return losses are below -1.68 dB and -8.13 dB, respectively, at the operating point 3.1 to 10.6 GHz. The maximum values for S_{11} and S_{22} are at -16.03 dB (at 7.96 GHz) and -19.19 dB (at 4.166 GHz), respectively. Figure 8(d) shows the reverse isolation is below -44.03 dB, indicating the performance of input and output ports of the design.



(a)

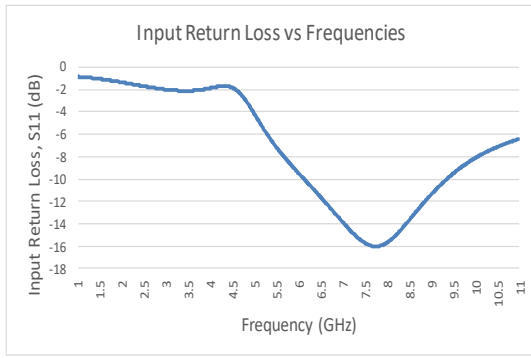

(b)

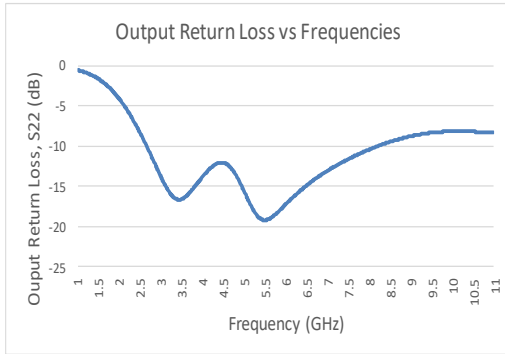

(c)

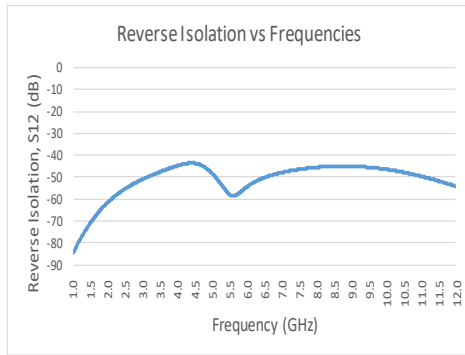

(d)

Figure 8: Simulated S-Parameter results. (a) Forward gain, S_{21} ; (b) Input return loss, S_{11} ; (c) Output return loss, S_{22} ; (d) Reverse isolation, S_{12}

Figure 9 shows that the power amplifier is unconditionally stable and it is verified that the amplifier will not oscillate at 3.1 GHz-10.6 GHz. The linearity illustrated in Figure 10 is from the periodic steady state (pss) simulation. It is showed that the input of 1-dB compression is at -29 dBm, while the PA delivers an output of -3.17 kdBm at this point. For this proposed design, the power consumption is considered high, for about 2.974 W from 1.8 V voltage supply because of the implementation of the notch filter. The comparison of previous and this design is shown in Table 2.

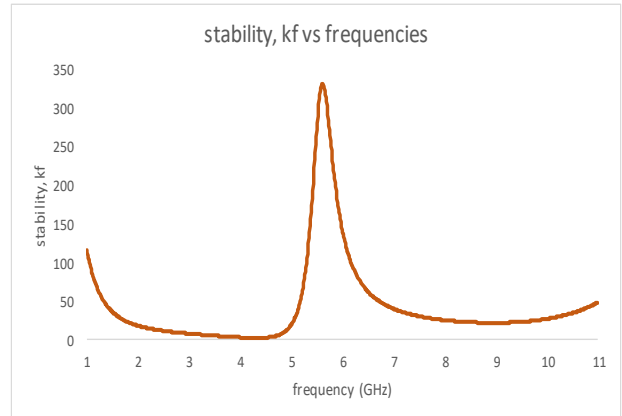

Figure 9: Stability, kf versus frequencies.

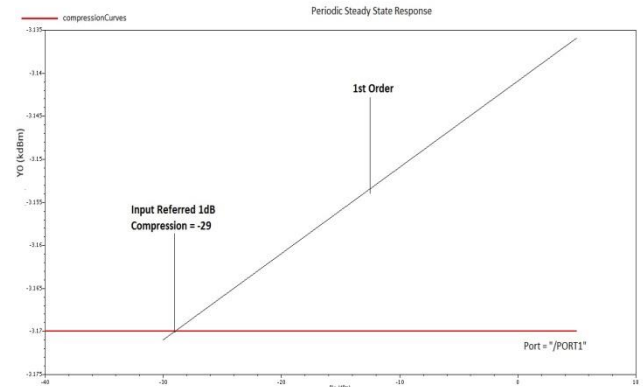

Figure 10: Linearity of UWB PA

Table 2
Performance of UWB CMOS PA.

Ref & Year	Techniques	Tech. (μm)	Freq. (GHz)	Gain, S_{21} (dB)	S_{11} (dB)	S_{22} (dB)	Power Consumption (Watt)
[12] 2006	Distributed Amplifier	0.18	3.0-12.6	10.46	<-10	<-10	84m
[13] 2006	RLC matching	0.18	3.1-10.6	8	<-9	<-8	25.2m
[9] 2012	Resistive Shunt Feedback	0.18	3.1-10.6	11.48	<-10	<-14	100m
[14] 2013	Resistive Shunt Feedback	0.18	3.1-10.6	12.4	<-8.6	<-8.6	19m
[10] 2016	Stagger Tuning	0.18	3.1-10.6	18	<-10	<-8.4	N/A
Proposed Work	Resistive Feedback	0.18	3.1-5 & 6-10.6	19.25 (max)	-1.68 ~ -16.03	-8.13 ~ -19.19	2.97

IV. CONCLUSION

A high gain of 3.1 GHz to 10.6 GHz UWB power amplifier with a notch filter is designed to cancel out the overlapping frequencies. Such design operates in 0.18 μm CMOS technology. The resistive feedback and cascade common

source show an acceptable power gain and a good matching network. Furthermore, the wide range of gain and flatness are also achieved in this design. Apart from that, the power amplifier shows an excellent stability factor which shows no oscillation occurs during the operation of this amplifier. Besides, the application of notch filter also shows good

effects in gain with the success of filtering out a certain range of frequency. However, this design consumes high power because of the implementation of the filter. Therefore, more research and improvements are crucial for future power amplifier with a filter development to fulfil UWB communication requirements.

ACKNOWLEDGEMENT

This work was supported by Universiti Malaysia Sarawak and OSAKA gas Foundation in Cultural Exchange (OGFICE) Research Grant Scheme.

REFERENCES

- [1] R. Sapawi, D. H. A. Mohamad, D. S. A. A. Yusuf, S. K. Sahari, D. N. S. D. A. Salleh, N. A. H. A. Hazis, and S. A. Z. Murad, "CMOS Power Amplifier Design Techniques for UWB Communication: A Review," *Journal of Telecommunication, Electronic and Computer Engineering*, vol 9, no 2-10, pp 1-8, 2017.
- [2] S. A. Z. Murad, R. K. Pokharel, R. Sapawi, H. Kanaya, and K. Yoshida, "High efficiency, good linearity, and excellent phase linearity of 3.1-4.8 GHz CMOS UWB PA with a current-reused technique," *IEEE Trans. Consum. Electron.*, vol. 56, no. 3, pp. 1241–1246, 2010.
- [3] H. Mosalam, A. Allam, H. Jia, R. Pokharel, M. Ragab, and K. Yoshida, "A 5-9 GHz CMOS Ultra-wideband power amplifier design using load-pull," *Proc. IEEE Int. Conf. Electron. Circuits, Syst.*, pp. 13–16, 2013.
- [4] S. A. Z. Murad, R. K. Pokharel, A. I. A. Galal, R. Sapawi, H. Kanaya, and K. Yoshida, "An excellent gain flatness 3.0-7.0 GHz CMOS PA for UWB applications," *IEEE Microw. Wirel. Components Lett.*, vol. 20, no. 9, pp. 510–512, 2010.
- [5] R. Sapawi, R. K. Pokharel, S. A. Z. Murad, D. A. A. Mat, H. Kanaya, and K. Yoshida, "Low power, low group delay MB-OFDM UWB CMOS power amplifier using current-reused technique," in *IEEE Region 10 Annual International Conference, Proceedings/TENCON*, 2011.
- [6] R. Sapawi, S. A. Zainol Murad, and D. A. A. Mat, "5–11GHz CMOS PA with 158.9 ± 41 ps group delay and low power using current-reused technique," *AEU - Int. J. Electron. Commun.*, vol. 66, no. 11, pp. 928–932, 2012.
- [7] C. Grewing, K. Winterberg, S. Van Waasen, M. Friedrich, G. L. Puma, A. Wiesbauer, and C. Sandner, "Fully integrated distributed power amplifier in CMOS technology, optimized for UWB transmitters," *2004 IEEE Radio Freq. Integr. Circuits Syst. Dig. Pap.*, pp. 87–90, 2004.
- [8] C. Lu, a.-V. Pham, and M. Shaw, "A CMOS power amplifier for full-band UWB transmitters," *IEEE Radio Freq. Integr. Circuits Symp.* 2006, vol. 1, pp. 1–4, 2006.
- [9] R. Sapawi, R. K. Pokharel, S. A. Z. Murad, A. Anand, N. Koirala, H. Kanaya, and K. Yoshida, "Low Group Delay 3.1-10.6 GHz CMOS Power Amplifier for UWB Applications," vol. 22, no. 1, pp. 41–43, 2012.
- [10] S. Hanen, M. Dhieb, H. Chariani, and M. Lahiani, "3.1-10.6 GHz high linearity, excellent gain flatness CMOS Power Amplifier for UWB Applications using stagger tuning technique."
- [11] S. A. Z. Murad, M. M. Shahimim, R. K. Pokharel, H. Kanaya, and K. Yoshida, "A 6-10.6 GHz CMOS PA with common-gate as an input stage for UWB transmitters," in *IEEE Region 10 Annual International Conference, Proceedings/TENCON*, 2011.
- [12] C. Lu, A.-V. Pham, and M. Shaw, "A CMOS Power Amplifier for Full-Band UWB Transmitters," *Radio Freq. Integr. Circuits Symp.* 2006 IEEE, 2006.
- [13] H. C. Hsu, Z. W. Wang, and G. K. Ma, "A low power CMOS full-band UWB power amplifier using wideband RLC matching method," in *2005 IEEE Conference on Electron Devices and Solid-State Circuits, EDSSC*, 2006.
- [14] R. Sapawi, S. K. Sahari, and K. Kipli, "A low power 3.1-10.6 GHz ultra-wideband CMOS power amplifier with resistive shunt feedback technique," in *Proceedings - 2013 International Conference on Advanced Computer Science Applications and Technologies, ACSAT 2013*, 2014.